

## N And P-Channel Enhancement Mode MOSFET

### Description

The NP6661BD6 uses advanced trench technology to provide excellent  $R_{DS(ON)}$  and low gate charge. The complementary MOSFETs may be used to form a level shifted high side switch, and for a host of other applications.

### General Features

◆ **N-channel:**

$V_{DS} = 30V, I_D = 20A$

$R_{DS(ON)} = 9.7m\Omega$  (typical) @  $V_{GS} = 10V$

$R_{DS(ON)} = 15.1m\Omega$  (typical) @  $V_{GS} = 4.5V$

◆ **P-Channel:**

$V_{DS} = -30V, I_D = -20A$

$R_{DS(ON)} = 21.2m\Omega$  (typical) @  $V_{GS} = -10V$

$R_{DS(ON)} = 33.4m\Omega$  (typical) @  $V_{GS} = -4.5V$

- ◆ Excellent gate charge x  $R_{DS(ON)}$  product(FOM)
- ◆ Very low on-resistance  $R_{DS(ON)}$
- ◆ 150 °C operating temperature
- ◆ Pb-free lead plating
- ◆ 100% UIS tested

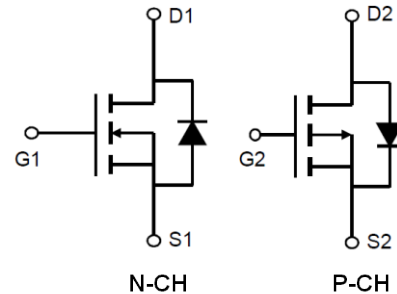
*100% UIS TESTED!*

*100%  $\Delta V_{ds}$  TESTED!*

### Application

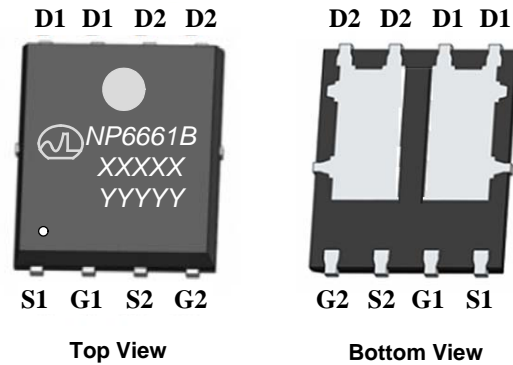
- ◆ Pch+Nch Complementary MOSFET for DC-FAN
- ◆ H-Bridge application

### Schematic diagram



### Marking and pin assignment

PDFN5x6-8L-B



XXXX—Wafer Information  
YYYY—Quality Code

### Ordering Information

Part Number	Storage Temperature	Package	Devices Per Reel
NP6661BD6-G	-55°C to +150°C	PDFN5*6-8L-B	5000

### Absolute Maximum Ratings (TA=25°C unless otherwise noted)

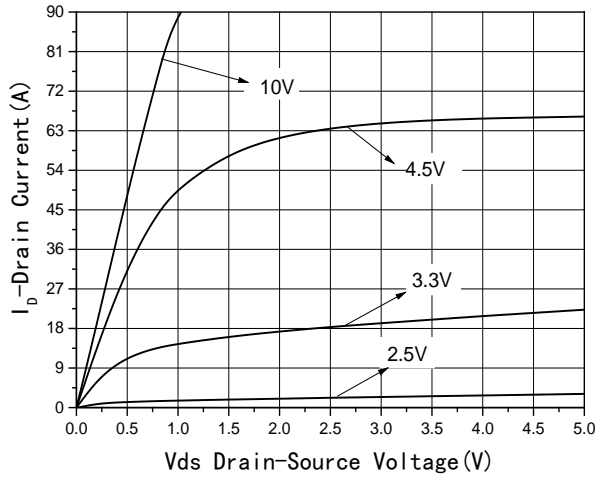
Parameter	Symbol	Limit		Unit	
		N	P		
Drain-source voltage	$V_{DS}$	30	-30	V	
Gate-source voltage	$V_{GS}$	±20	±20	V	
Operating junction Temperature range	$T_j$	-55—150	-55—150	°C	
Drain Current-Continuous (Silicon Limited)	$T_A = 25^\circ C$	$I_D$	20	-20	A
	$T_A = 75^\circ C$		15	-15	

Pulsed Drain Current (Package Limited)		$I_{DM}$	72	-72	A
Avalanche Current <sup>C</sup>		$I_{AS}, I_{AR}$	22	-27	A
Avalanche energy $L=0.1\text{mH}^C$		$E_{AS}, E_{AR}$	24	36	mJ
Power Dissipation <sup>B</sup>	$T_A=25^\circ\text{C}$	$P_D$	12	20	W
	$T_A=75^\circ\text{C}$		5	8	
Junction and Storage Temperature Range		$T_J, T_{STG}$	-55—150		$^\circ\text{C}$

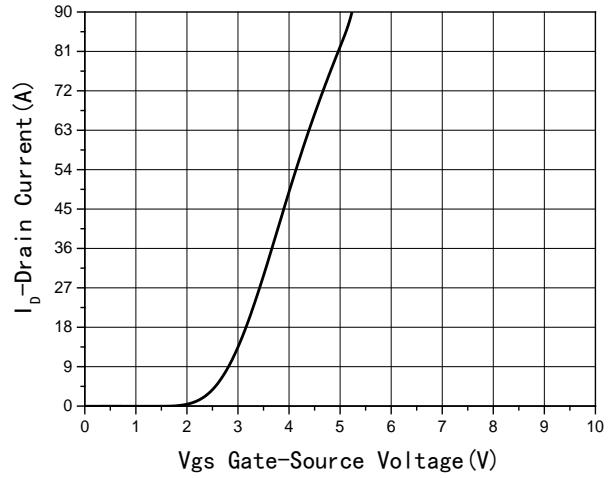
**N-Channel Electrical Characteristics** ( $T_J=25^\circ\text{C}$  unless otherwise noted)

Parameter	Symbol	Condition	Min	Typ	Max	Unit
<b>OFF Characteristics</b>						
Drain-source breakdown voltage	$BV_{DSS}$	$V_{GS}=0V, I_D=250\mu\text{A}$	30	-	-	V
Zero gate voltage drain current	$I_{DSS}$	$V_{DS}=30V, V_{GS}=0V$	-	-	1	$\mu\text{A}$
Gate-body leakage	$I_{GSS}$	$V_{DS}=0V, V_{GS}=\pm 20V$	-	-	$\pm 100$	nA
<b>ON Characteristics</b>						
Gate threshold voltage	$V_{GS(th)}$	$V_{DS}=V_{GS}, I_D=250\mu\text{A}$	1.0	1.73	3.0	V
Drain-source on-state resistance	$R_{DS(on)}$	$V_{GS}=10V, I_D=20A$	-	9.7	10.5	m $\Omega$
		$V_{GS}=4.5V, I_D=20A$	-	15.1	17.5	
Forward transconductance	gfs	$V_{DS}=5V, I_D=20A$	-	43	-	S
<b>Dynamic Characteristics</b>						
Input capacitance	$C_{ISS}$	$V_{DS}=15V, V_{GS}=0V$ $f=1.0\text{MHz}$	-	985	-	pF
Output capacitance	$C_{OSS}$		-	132	-	
Reverse transfer capacitance	$C_{RSS}$		-	114	-	
Gate resistance	$R_g$	$V_{GS}=0V, V_{DS}=0V,$ $f=1.0\text{MHz}$	-	1.6	2.4	$\Omega$
<b>Switching Characteristics</b>						
Turn-on delay time	$t_{D(ON)}$	$V_{DS}=15V$ $V_{GS}=10V$ $R_L=1.5\Omega$ $R_{GEN}=3\Omega$	-	4.4	-	ns
Rise time	$t_r$		-	9	-	
Turn-off delay time	$t_{D(OFF)}$		-	17	-	
Fall time	$t_f$		-	6	-	
Total gate charge	$Q_g$	$V_{DS}=15V, I_D=20A$ $V_{GS}=10V$	-	19.9	-	nC
Gate-source charge	$Q_{gs}$		-	3.7	-	
Gate-drain charge	$Q_{gd}$		-	4	-	

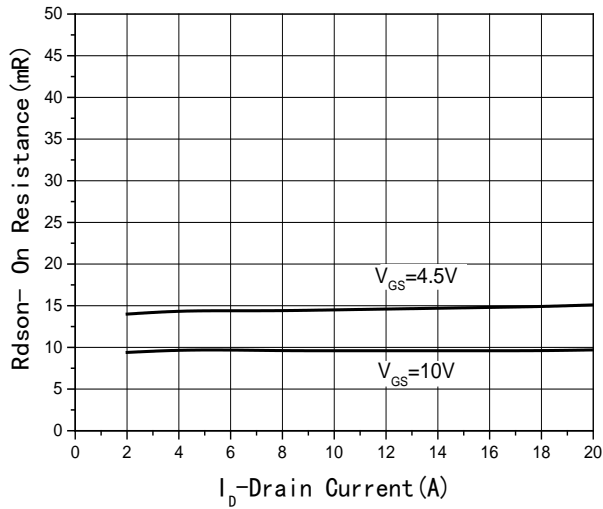
## Typical Performance Characteristics



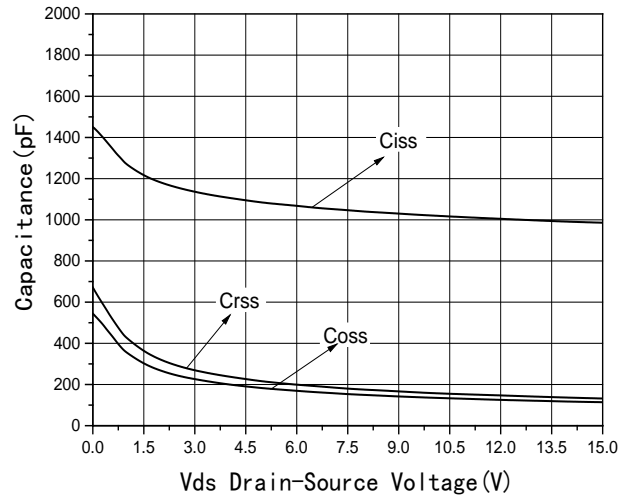
**Fig1 Output Characteristics**



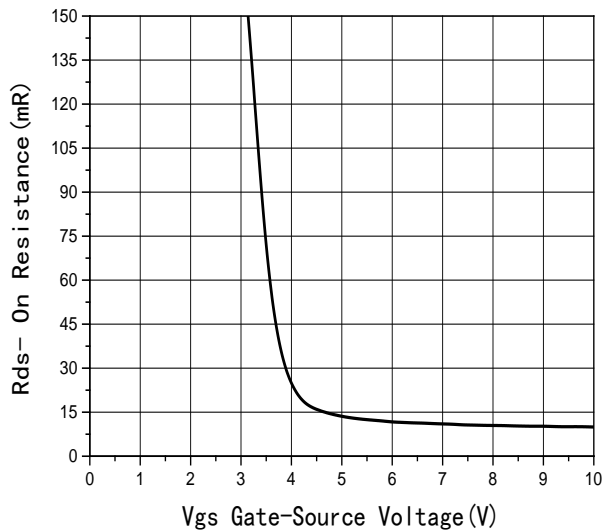
**Fig2 Transfer Characteristics**



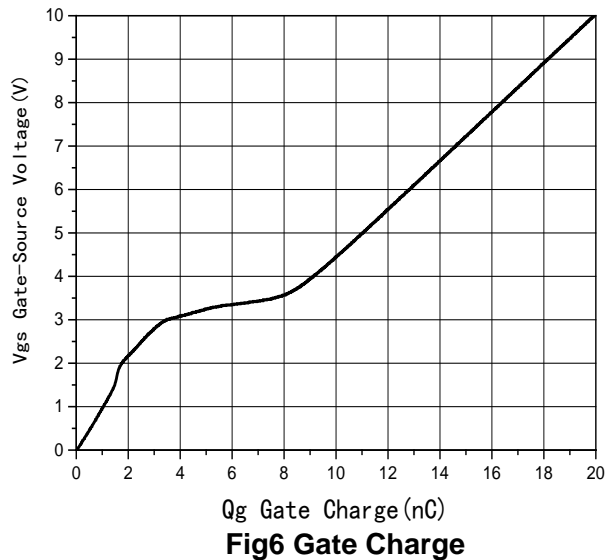
**Fig3  $R_{DS(on)}$ -Drain current**



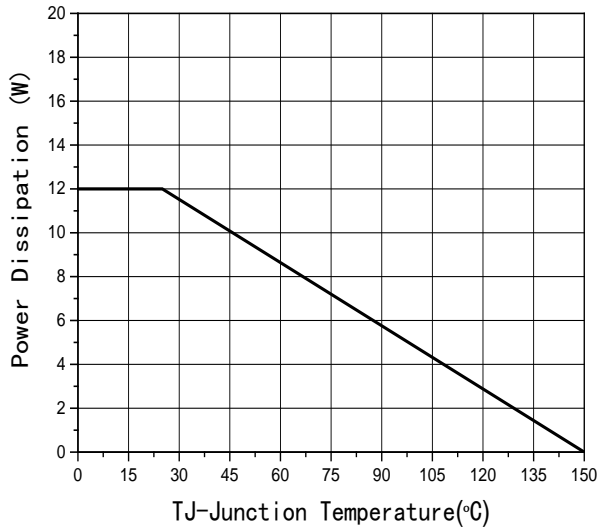
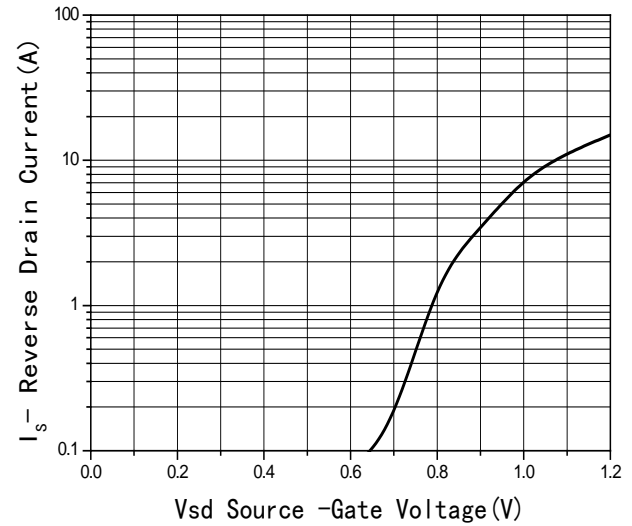
**Fig4 Capacitance vs  $V_{DS}$**



**Fig5  $R_{DS(on)}$ -Gate Drain voltage**

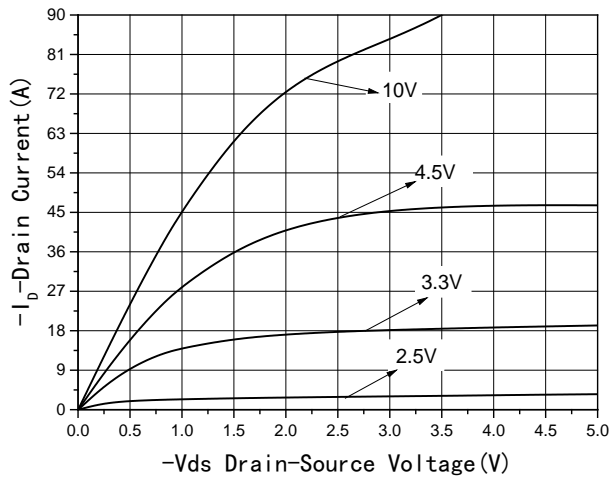


**Fig6 Gate Charge**

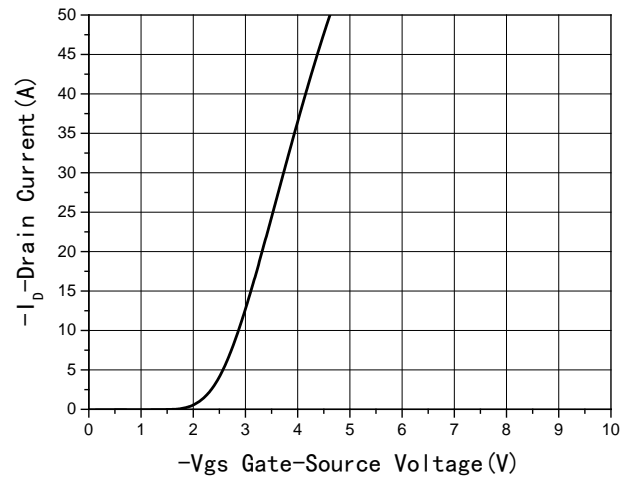

**Fig7 Power De-rating**

**Fig8 Source-Drain Diode Forward**
**P-Channel Electrical Characteristics** (T<sub>J</sub>=25°C unless otherwise noted)

Parameter	Symbol	Condition	Min	Typ	Max	Unit
<b>OFF Characteristics</b>						
Drain-source breakdown voltage	BV <sub>DSS</sub>	V <sub>GS</sub> =0V, I <sub>D</sub> =-250μA	-30	-	-	V
Zero gate voltage drain current	I <sub>DSS</sub>	V <sub>DS</sub> =-30V, V <sub>GS</sub> =0V	-	-	-1	μA
Gate-body leakage	I <sub>GSS</sub>	V <sub>DS</sub> =0V, V <sub>GS</sub> =±20V	-	-	±100	nA
<b>ON Characteristics</b>						
Gate threshold voltage	V <sub>GS(th)</sub>	V <sub>DS</sub> =V <sub>GS</sub> , I <sub>D</sub> =-250μA	-1	-1.6	-2.5	V
Drain-source on-state resistance	R <sub>DS(ON)</sub>	V <sub>GS</sub> =-10V, I <sub>D</sub> =-20A	-	21.2	25.5	mΩ
		V <sub>GS</sub> =-4.5V, I <sub>D</sub> =-20A	-	33.4	40.5	
Forward transconductance	g <sub>fs</sub>	V <sub>DS</sub> =-5V, I <sub>D</sub> =-10A	-	18	-	S
<b>Dynamic Characteristics</b>						
Input capacitance	C <sub>ISS</sub>	V <sub>DS</sub> =-15V, V <sub>GS</sub> =0V f=1.0MHz	-	24	-	pF
Output capacitance	C <sub>OSS</sub>		-	4.6	-	
Reverse transfer capacitance	C <sub>RSS</sub>		-	4.2	-	
Gate resistance	R <sub>g</sub>	V <sub>GS</sub> =0V, V <sub>DS</sub> =0V, f=1.0MHz	-	4	-	Ω
<b>Switching Characteristics</b>						
Turn-on delay time	t <sub>D(ON)</sub>	V <sub>DS</sub> =-15V V <sub>GS</sub> =-10V R <sub>L</sub> =2.3Ω R <sub>GEN</sub> =3Ω	-	10	-	ns
Rise time	t <sub>r</sub>		-	5.5	-	
Turn-off delay time	t <sub>D(OFF)</sub>		-	3.6	-	
Fall time	t <sub>f</sub>		-	4.6	-	
Total gate charge	Q <sub>g</sub>	V <sub>DS</sub> =-15V, I <sub>D</sub> =-20A V <sub>GS</sub> =-10V	-	1261	-	nC
Gate-source charge	Q <sub>gs</sub>		-	152	-	
Gate-drain charge	Q <sub>gd</sub>		-	137	-	

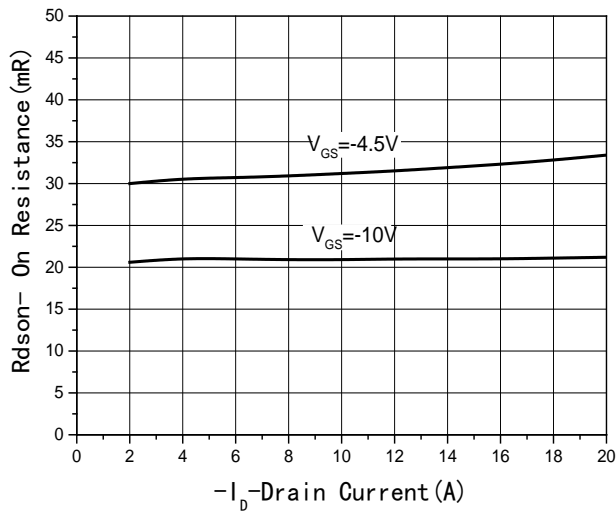
## Typical Performance Characteristics



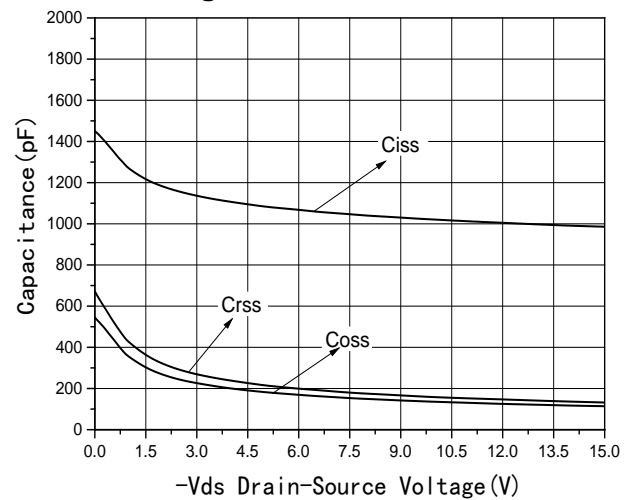
**Fig1 Output Characteristics**



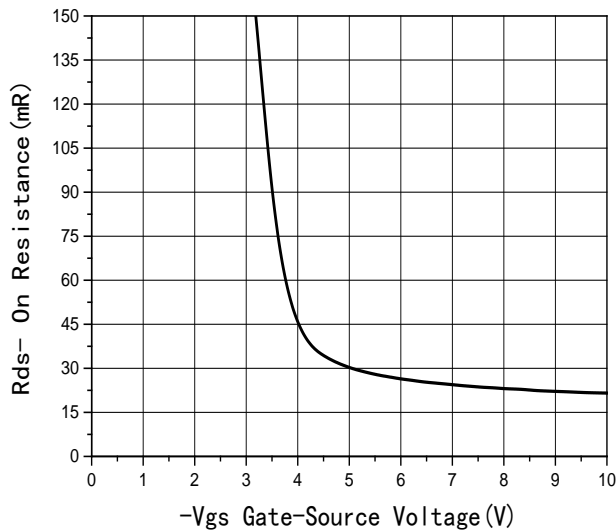
**Fig2 Transfer Characteristics**



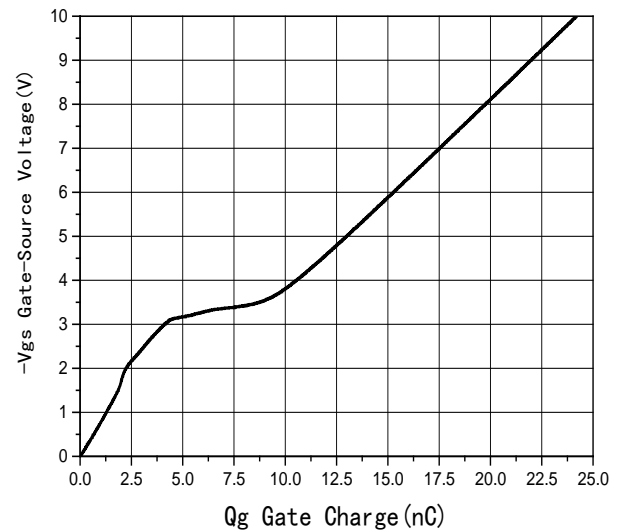
**Fig3  $R_{ds(on)}$ -Drain current**



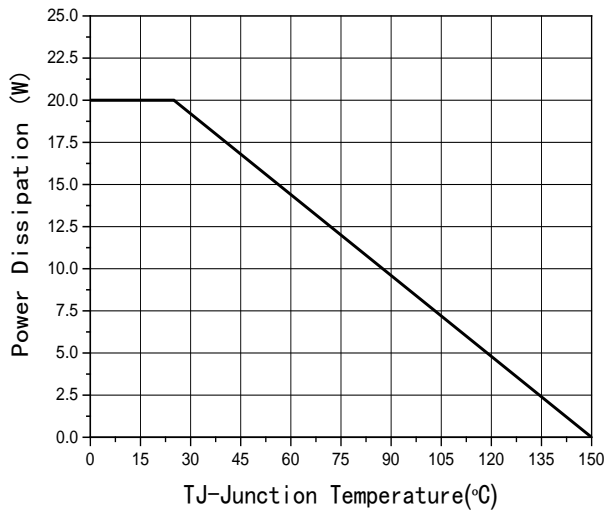
**Fig4 Capacitance vs  $V_{DS}$**



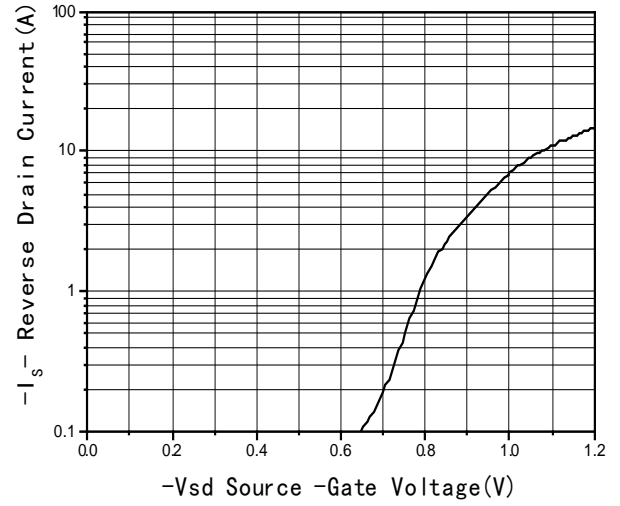
**Fig5  $R_{ds(on)}$ -Gate Drain voltage**



**Fig6 Gate Charge**



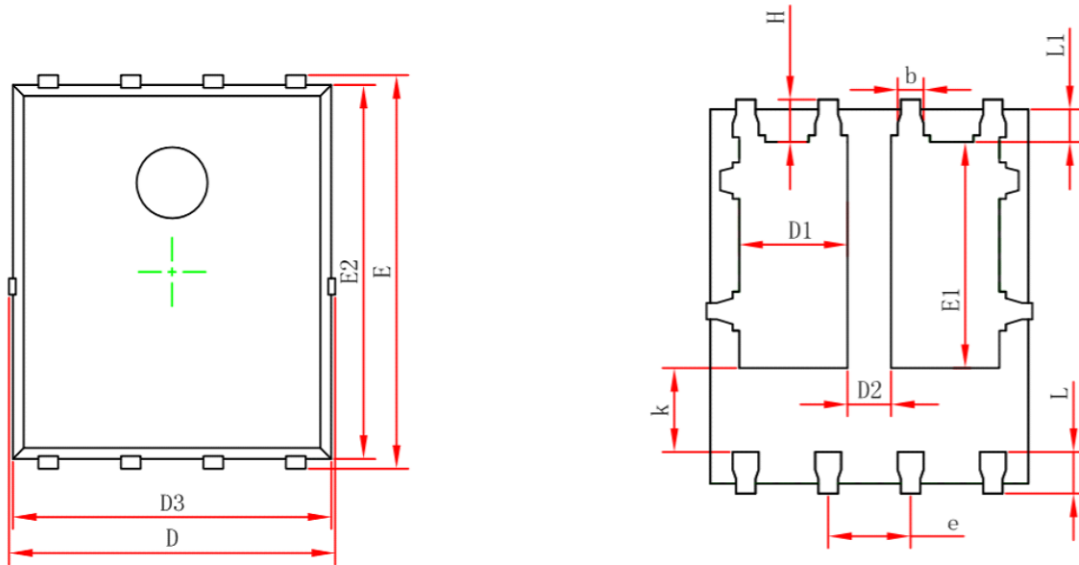
**Fig7 Power De-rating**



**Fig8 Source-Drain Diode Forward**

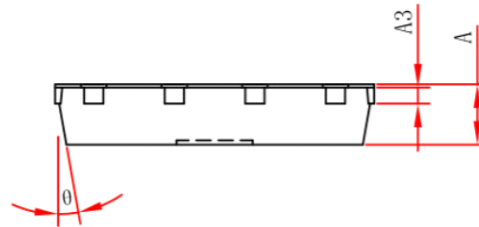
## Package Information

- PDFN5\*6-8L-B



**Top View**

**Bottom View**



**Side View**

Symbol	Dimensions In Millimeters		Dimensions In Inches	
	Min.	Max.	Min.	Max.
A	0.900	1.000	0.035	0.039
A3	0.154REF.		0.006REF.	
D	4.944	5.096	0.195	0.201
E	5.974	6.126	0.235	0.241
D1	1.470	1.870	0.058	0.074
D2	0.470	0.870	0.019	0.034
E1	3.375	3.575	0.133	0.141
D3	4.824	4.976	0.190	0.196
E2	5.674	5.826	0.223	0.229
k	1.190	1.390	0.047	0.055
b	0.350	0.450	0.014	0.018
e	1.270TYP.		0.050TYP.	
L	0.559	0.711	0.022	0.028
L1	0.424	0.576	0.017	0.023
H	0.574	0.726	0.023	0.029
θ	10°	12°	10°	12°